



Ø182x55 mm



Impeller: Plastic

Ambient Temperature Range: -10°C ~ +70°C

Operating Voltage Range: Rated Voltage ±10%

Bearing: Ball bearing

Motor Structure: Shaded Pole Motor or Capacitor induction

Motor protection: Thermal Protected

Termination: Lead wire

Package: 1200g / PC

Dimension (units:mm)

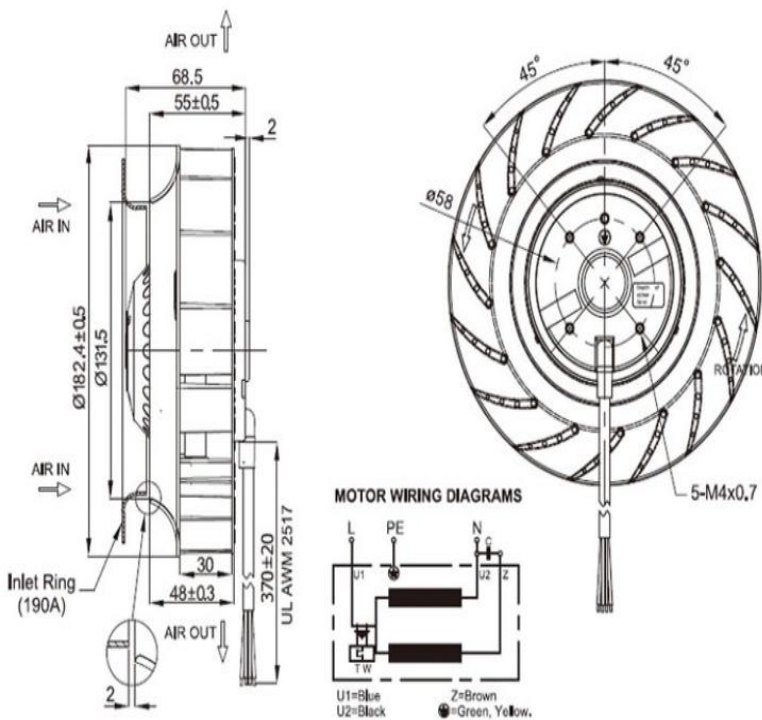

Characteristic Curves

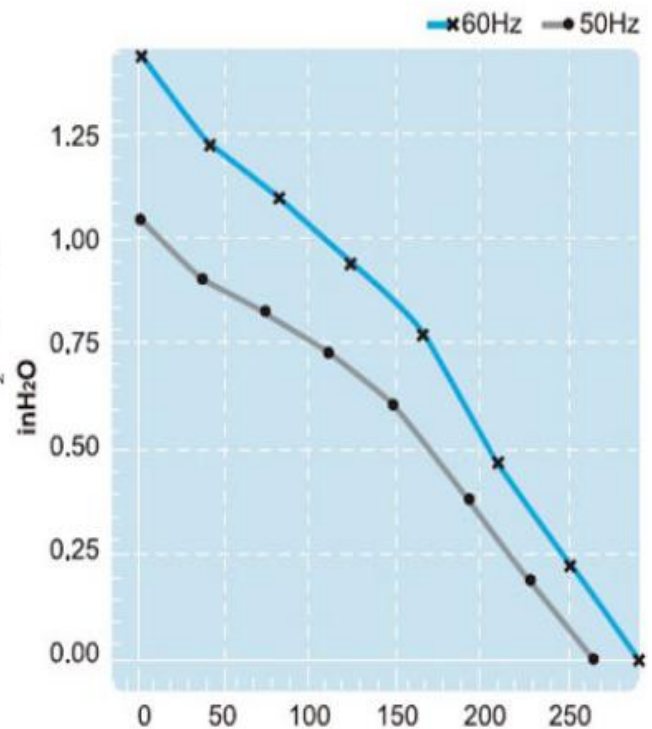

AC Centrifugal Fan

SPECIFICATION

Model	Voltage (V)	Freq. (Hz)	Current (A)	Power (W)	Speed (RPM)	Air Flow (CFM)	Pressure (mm Aq)	Noise (dB)
CYC11855HB	115	50/60	0.6/0.7	63/78	2550/2800	265/290	26/36	64/67
CYC21855HB	230	50/60	0.3/0.34	63/78	2550/2800	265/290	26/36	64/67