



ø190x87 mm



Impeller: Plastic

Ambient Temperature Range: -10°C ~ +70°C

Operating Voltage Range: Rated Voltage ±10%

Bearing: Ball bearing

Motor Structure: Shaded Pole Motor or Capacitor induction

Motor protection: Thermal Protected

Termination: Lead wire

Package: 1500g / PC

Dimension (units:mm)

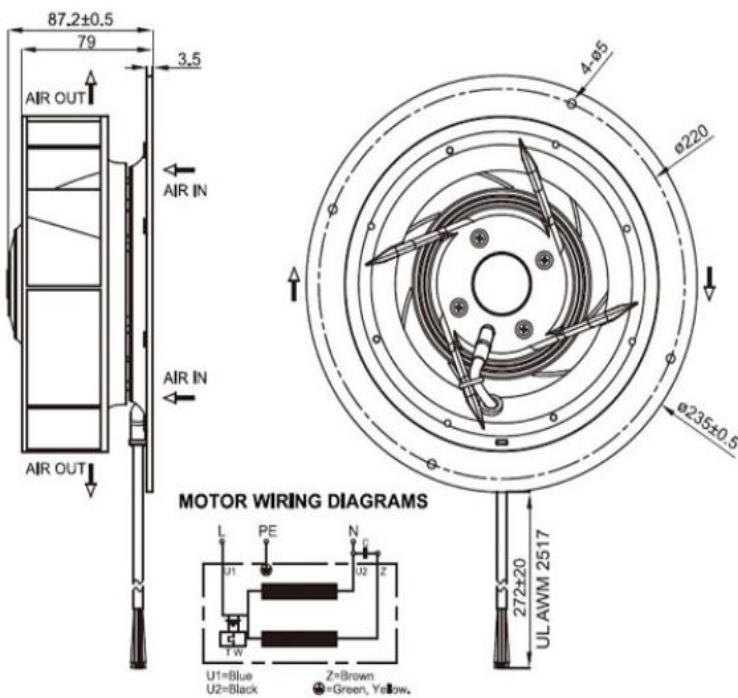

Characteristic Curves

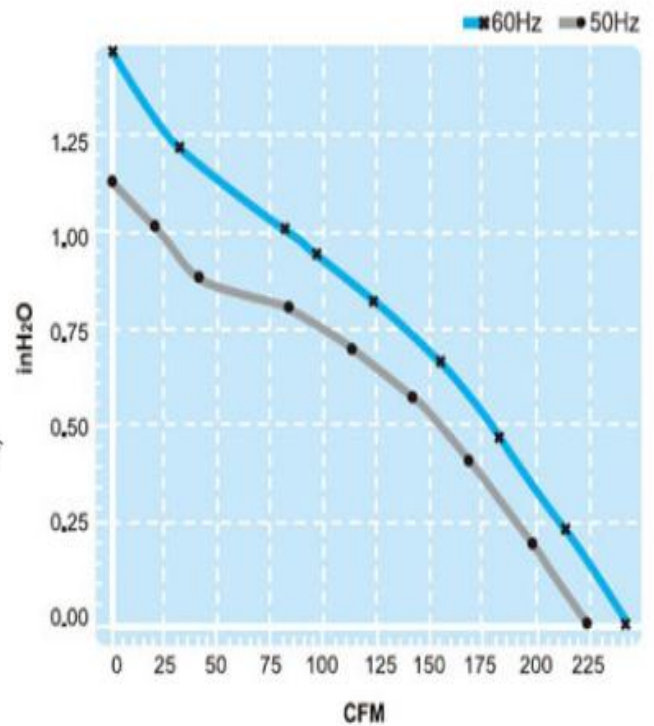

AC Centrifugal Fan

SPECIFICATION

Model	Voltage (V)	Freq. (Hz)	Current (A)	Power (W)	Speed (RPM)	Air Flow (CFM)	Pressure (mm Aq)	Noise (dB)
CYC11987HB	115	50/60	0.45/0.54	55/65	2500/2700	230/247	29/38	60/63
CYC21987HB	230	50/60	0.23/0.3	57/72	2500/2700	230/247	29/38	60/63