



ø220x84 mm



**Impeller:** Plastic

**Ambient Temperature Range:** -10°C ~ +70°C

**Operating Voltage Range:** Rated Voltage ±10%

**Bearing:** Ball bearing

**Motor Structure:** Shaded Pole Motor or Capacitor induction

**Motor protection:** Thermal Protected

**Termination:** Lead wire

**Package:** 1500g / PC

Dimension (units:mm)

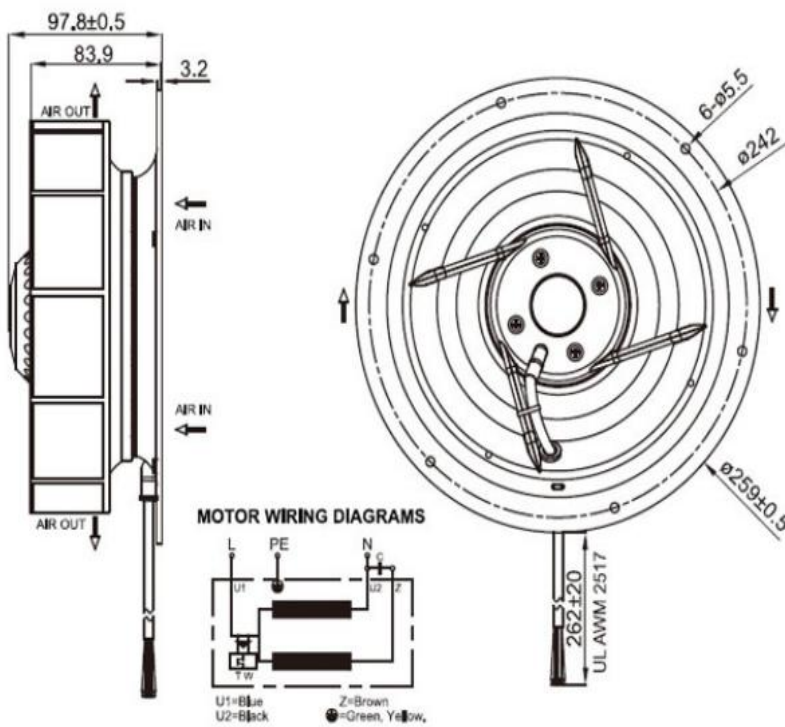

Characteristic Curves

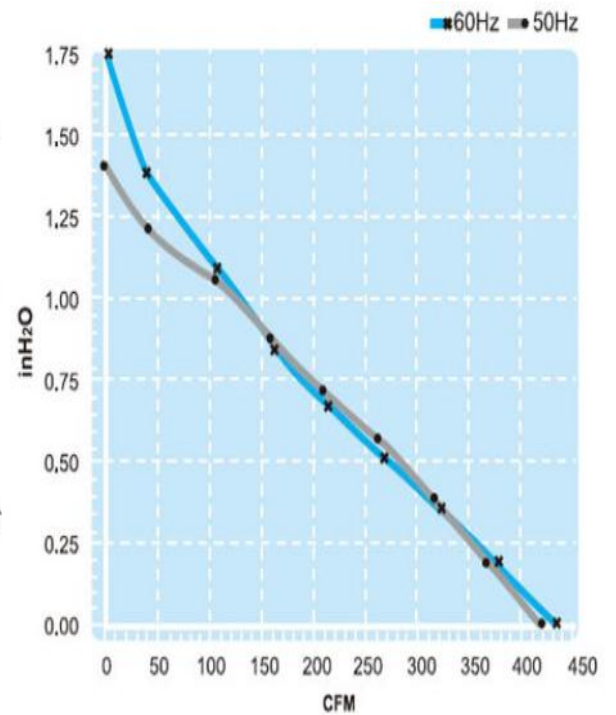

AC Centrifugal Fan

**SPECIFICATION**

Model	Voltage (V)	Freq. (Hz)	Current (A)	Power (W)	Speed (RPM)	Air Flow (CFM)	Pressure (mm Aq)	Noise (dB)
CYC12284HB	115	50/60	0.63/0.8	90/117	2500/2650	424/434	36/45	64/65
CYC22284HB	230	50/60	0.35/0.39	90/117	2500/2650	424/434	36/45	64/65