



Ø235x87 mm



**Impeller:** Plastic

**Ambient Temperature Range:** -10°C ~ +70°C

**Operating Voltage Range:** Rated Voltage ±10%

**Bearing:** Ball bearing

**Motor Structure:** Shaded Pole Motor or Capacitor induction

**Motor protection:** Thermal Protected

**Termination:** Lead wire

**Package:** 1500g / PC

### Dimension (units:mm)

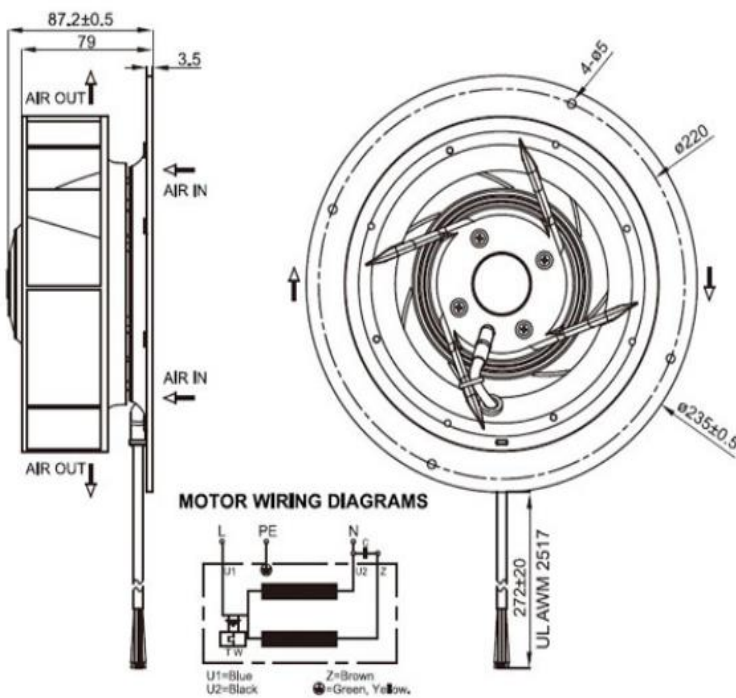

### Characteristic Curves

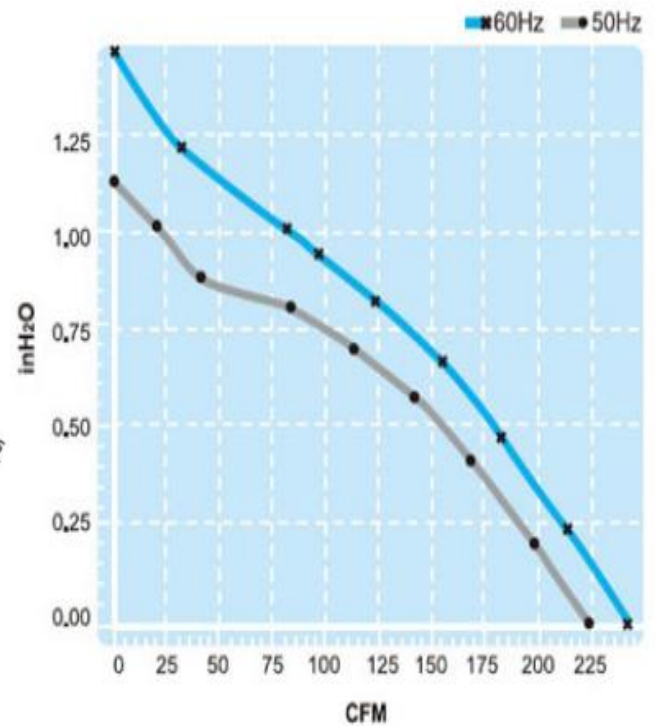

AC Centrifugal Fan

## SPECIFICATION

Model	Voltage (V)	Freq. (Hz)	Current (A)	Power (W)	Speed (RPM)	Air Flow (CFM)	Pressure (mm Aq)	Noise (dB)
CYC12387HB	115	50/60	0.45/0.54	55/65	2500/2700	230/247	29/38	60/63
CYC22387HB	230	50/60	0.23/0.3	57/72	2500/2700	230/247	29/38	60/63