



□220x97 mm



**Frame:** Aluminum

**Impeller:** plastic (UL 94V-0)

**Ambient Temperature Range:** -10°C ~ +70°C

**Bearing:** Ball

**Weight:** 1300 g

### Dimension (units:mm)

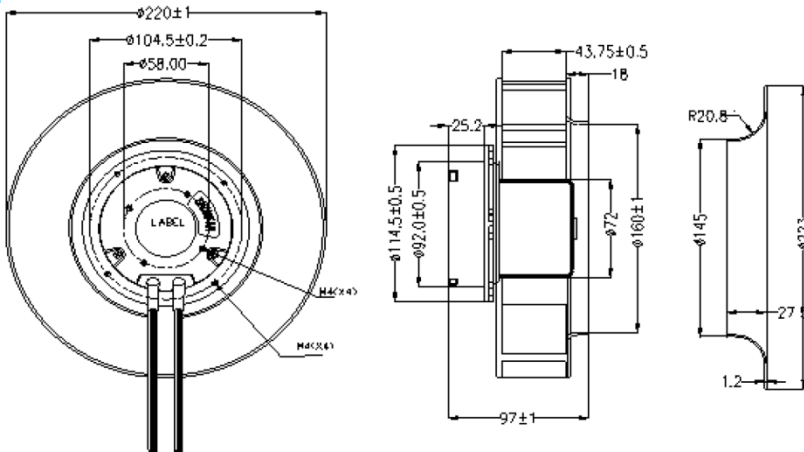

### Characteristic Curves

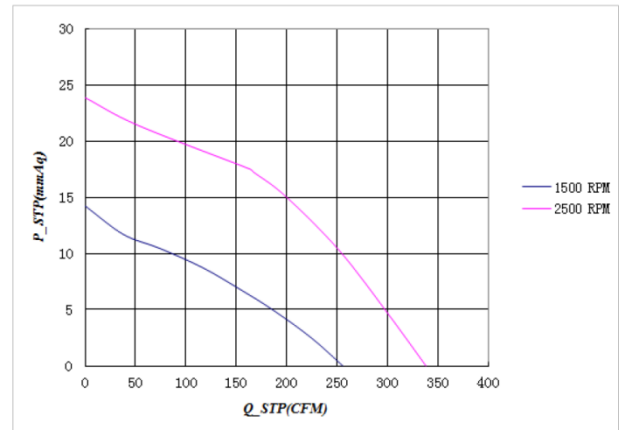

## SPECIFICATION

Model	Voltage (V)	Operating Range(V)	Freq. (Hz)	Power (W)	Speed (RPM)	Air Flow (CFM)	Air Flow (m3/min)	Pressure (in-H2O)	Noise (dB)
CYEC12297HB	110	80-135	50/60	85	2500	338	9.58	0.94	58
CYEC22297HB	220	180-265							

- If you want another RPM or Voltage or Functions which not in the list. Please contact with us. We can customize for you.
- Specifications are subject to change without notice.