



□250x130 mm



Frame: Aluminum

Impeller: plastic (UL 94V-0)

Ambient Temperature Range: -10°C ~ +70°C

Bearing: Ball

Weight: 2000 g

Dimension (units:mm)

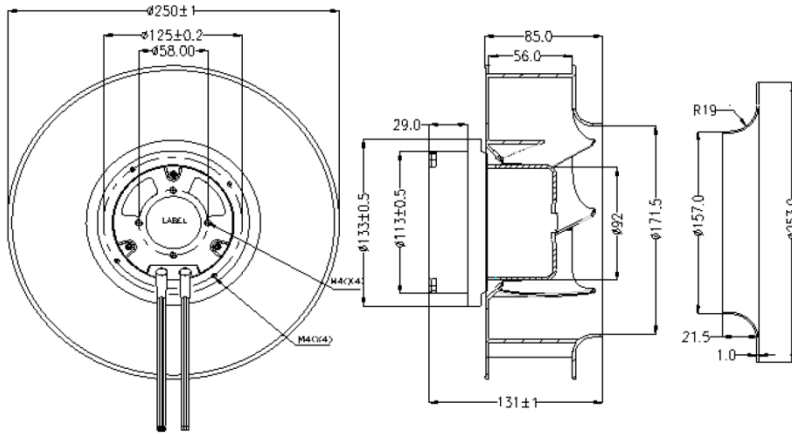

Characteristic Curves

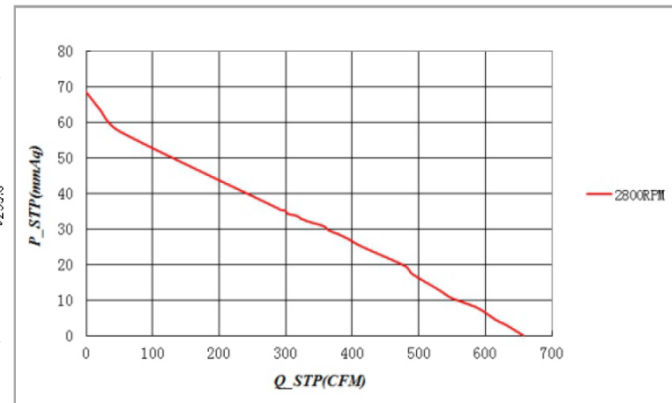

SPECIFICATION

Model	Voltage (V)	Operating Range(V)	Freq. (Hz)	Power (W)	Speed (RPM)	Air Flow (CFM)	Air Flow (m3/min)	Pressure (in-H2O)	Noise (dB)
CYEC12513HB	110	80-135	50/60	123	2800	657	18.6	2.7	74
CYEC22513HB	220	180-265							

- If you want another RPM or Voltage or Functions which not in the list. Please contact with us. We can customize for you.
- Specifications are subject to change without notice.