



□ 171x150x51 mm



Frame: Aluminum

Impeller: Thermoplastic PBT 94V-0

Ambient Temperature Range: -10°C ~ +70°C

Bearing: Ball

Termination: Terminals or Lead wire

Weight: 655 g

Dimension (units:mm)

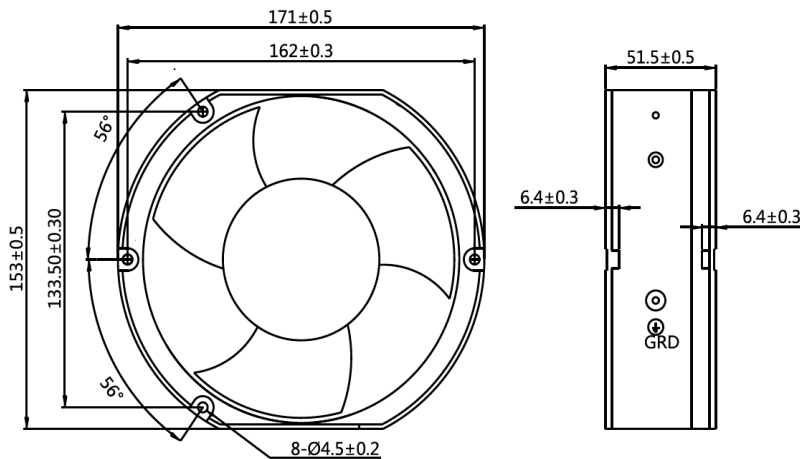

Characteristic Curves

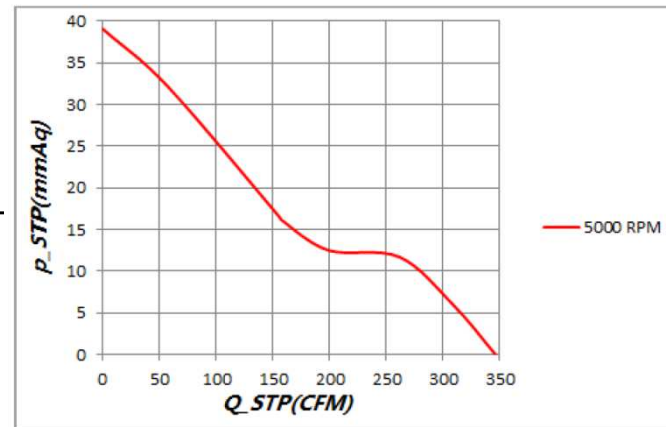

SPECIFICATION

Model	Voltage (V)	Operating Range(V)	Freq. (Hz)	Power (W)	Speed (RPM)	Air Flow (CFM)	Air Flow (m3/min)	Pressure (in-H2O)	Noise (dB)
CYE11751HB	110	80-135	50/60	70	5000	346	9.81	1.54	71
CYE21751HB	220	180-265		65					

- If you want another RPM or Voltage or Functions which not in the list. Please contact with us. We can customize for you.
- Specifications are subject to change without notice.

EC Axial Fan